

TECHNICAL
ORDER NO. **3-AJ-S-85**

30 SEPT 1985
CHANGE 1



THE ADVANCED FLIGHT SIMULATOR

OPERATIONS MANUAL

MICRO PROSE
SIMULATION • SOFTWARE

2, Market Place, Tetbury, Gloucestershire GL8 8DA
Tel: (0666) 54326
Fax: (0666) 54331 Tlx: 43422MPS UK G

BD-5J MicroJet™



OPERATIONS MANUAL

Copyright ©1985 by MicroProse Software
120 Lakefront Drive, Hunt Valley, MD 21030
(301) 667-1151

Dear Friend,

Aerobatic flying is a pilot's ultimate challenge. In AcroJet we're sharing with you some of the excitement, thrills, and split-second action of real aerobatic flying.

Don't be dismayed if you crash your AcroJet frequently. It's a high-strung and unforgiving aircraft. The key to successful aerobatics is to practice the maneuvers cautiously, safely, carefully, and with plenty of altitude. Only then can you attempt them at low altitude.

Aerobatic flying is a thrilling and dangerous sport that doesn't get the attention it deserves. We urge you to go watch a real event, see the planes overhead, and talk to the pilots and ground crews. You'll appreciate and enjoy AcroJet that much more.

This simulation is dedicated to sport, aerobatic and stunt pilots everywhere in the world. We want to bring you the excitement they feel every time they climb into the cockpit for a competition or just plain flying fun!

Although no real pentathlon or decathlon for sport aviation currently exists, continued promotion of sport aviation and aerobatics may produce such a competition in the future. In the meantime, although this simulation aims at realism, please don't attempt any of the maneuvers depicted here in a real aircraft! Aerobatic pilots have years of training and experience. Only the best would attempt in real life the maneuvers depicted in this product — low altitude aerobatics is extremely dangerous, with no leeway for human error or mechanical breakdown.

Most of all we want you to have fun. We've had fun making this product, and look forward to competing with you in the excitement of an AcroJet competition. Good Loops to You !!

William F. Denman, Jr.,
and the staff of MICROPROSE

GETTING A QUICK START

You can get airborne in your AcroJet simulator quickly by following the appropriate loading instructions, reviewing the cockpit layout found in the centerfold, and reading through the description on aircraft controls, on pages 8-11. Also see the centerfold cockpit layout on pages 20-21. Instructions for basic takeoff and landing techniques can be found right after the controls section.

Be sure to unlock your plane's controls when requested! The lock colors and appropriate lock codes are listed in alphabetical order throughout this manual. See page 6 for details.

INTRODUCTION

Flying is a sport for hundreds of thousands of Americans today. Light planes are reasonably inexpensive when bought "off the lot", and downright cheap if you build them yourself from a kit. Every weekend around the nation pilots converge on small airfields to fly for pleasure, in informal competitions, to conventions, or at formal competitions sponsored by the EAA and IAC.

This program lets you enjoy a simulation of sport flying. You can experience all the thrills of flying, even perform your own aerobatics. Better yet, you're flying the BD-5J "AcroJet", one of the few sport jets in existence. This plane is fast, maneuverable, very small, and very tricky. To fly one in real life you'd need years of training and experience. Here at MicroProse we wanted to let more people enjoy the thrill of sport flying in truly "hot" planes. The only answer was a computer simulation of the BD-5J.

Sport flying has numerous competitions, formal and informal. In keeping with the spirit of the BD-5J, we've presented ten aerobatic "events" that would test the mettle of any pilot. Fly any five for a "Pentathlon", or all ten for a grueling "Decathlon". Also included is an "unlimited" event where you can decide what pilots will perform, and judge them on it. This "human judging" of performance is the standard for international competition today.

We at MicroProse enjoy the challenges and hair-raising performance of the AcroJet. We know you will too, as you fly it from your living room! Have fun and good flying to you!

TABLE OF CONTENTS

Introduction	3
Loading	4
Startup Options	4
AcroJet Controls	8
AcroJet Cockpit Indicators	10
BD-5J Cockpit Layout (Centerfold)	20
Basic Maneuvers	12
Aerodynamics & Basic Flight	14
Aerobatic Flying	18
AcroJet Competition Events	22
BD-5J AcroJet Design	33
Sport Aviation	37



LOADING ACROJET INTO YOUR COMPUTER

Commodore C64

1. Attach ONE joystick at Port #2. Do NOT leave a joystick in port #1 (a joystick in port #1 can scramble your controls!).
2. Turn on your computer (if it's already on, remove any disks and cartridges, turn it off, then turn it on again). If you have a C-128, hold down the Shift and Commodore keys when you turn on your computer (this places it in C-64 mode). Next turn on your disk drive. **WARNING:** do not leave a disk in the drive when you are turning your computer off and on — your disk could be damaged!
3. Insert the disk in the disk drive and type the following:
LOAD "****",8,1

and press RETURN. The program will automatically begin loading. DO NOT touch the disk drive or turn off power while the program is loading. About a minute later the program will finish loading and the disk drive light will go off. Press any key to begin.

STARTUP OPTIONS

AcroJet has a large variety of aerobatic events, options, and pre-flight checkout steps. However, in every case you can advance quickly to the next option by pressing the fire button on the control stick. In addition, the following special controls are useful:

RUNSTOP RESTORE Restart: If you hold down the RUN STOP key, and then press the RESTORE key, the entire program restarts fresh from memory (no disk loading!). All entries are forgotten except new Hall of Fame records (see WGSP Hall of Fame below for details on clearing that).

Title and Credits

When AcroJet begins loading, you will see a colorful title screen.

Press Any Key: When loading is finished (light on the disk drive goes out), pressing any key will advance you to the WGSP Hall of Fame.

Automatic Demonstration: If you do not press a key, the demonstration starts automatically. Pressing any key during the demonstration returns you to the title screen.

WGSP Hall of Fame

The World's Greatest Sport Pilot (WGSP) Hall of Fame posts scoring records for the top Pentathlon and Decathlon flyers, as well as best scores in single events.

Press Any Key (except CTRL c) to leave this screen and continue.

CTRL c Reset: If you hold down the CTRL key and press the C key, all names and scores are cleared from the WGSP Hall of Fame. You have "cleared the record books" and are ready to start fresh.

Pilot Registration

Here you register for an event by selecting either the Decathlon (all ten events), the Pentathlon (any five events), a single event, or an "Unlimited" event (a single event where you control the activity, time limit, and judging).

Control Stick Up/Down moves the highlight cursor up and down the screen. The competition currently selected (Decathlon, Pentathlon, Single Event, or Unlimited) is indicated by a "****".

Control Stick Left/Right changes the highlighted selection.

Type to Enter Your Name: When you're finished press RETURN once. Each name is limited to eight characters, including blank spaces.

Control Stick Fire Button exits the screen. Don't press it until you're done making selections!

Unlimited Event Selection

This screen only appears if you have selected an "unlimited" event.

Control Stick Up/Down moves the highlight cursor up and down the screen.

Control Stick Left/Right changes/erases the highlighted selection.

Event Name: You can type up to 20 characters, including blank spaces. When you're finished press RETURN once.

Adjust Difficulty Factor: You can adjust the difficulty rating for the event with the control stick, or by typing a new value. Difficulty factors range from 1.0 (for the easiest event) to 3.0 (for the hardest). Type the appropriate digits in the highlighted space.

Timed vs Untimed: If you select a timed event, the time it takes to complete the event becomes an important part of the score. If you select an untimed event, the judge's opinion is a large part of your score.

Course Layout: You can select any course by number.

Course 1 and 2 - four pylons (NE, SE, NW, SW); Courses 3 and 4 - two ribbon gates side by side SW of the airfield; Course 5 - two ribbon gates east and west of the airfield; Course 6 - three ribbon gates NE, SE, and W of the airfield; Course 7 - one ribbon gate west of the airfield; Course 8 - landing field only; Course 9 - two ribbon gates east and west of the airfield.

Control Stick Fire Button exits the screen. Don't press it until you're done making selections!

Event Selection

Here you can review or select the events in the competition. If you are flying the Pentathlon, select any five events. If you are flying the Decathlon, you must fly all ten. If you select fewer, other events will be selected for you.

The arrows on the sides indicate events selected, the highlight cursor can be moved up and down to select/deselect different events.

Control Stick Up/Down moves the highlight cursor up and down the screen.

Control Stick Left/Right selects or removes an event. You can also select an event by typing its number (type 0 for event 10, + for item 11 — the normal defaults)

IMPORTANT: You must de-select an event (move cursor to it and flip joystick left or right) before selecting a new event.

Flight Clearance

Now you are ready to fly. You can select the level of weather difficulty and jet performance. The greater the overall difficulty you select, the higher you can score.

Control Stick Up/Down moves the highlight cursor up and down the screen.

Control Stick Left/Right changes/erases the highlighted selection.

Difficulty: You can select four different levels of wind conditions. The lowest level is intended for novices, it allows you to roll on and off the runway without damage, and to fly through pylons without damage.

Jet Performance: You can select four different levels of aircraft performance. At the highest level controls are realistically sensitive, at lower levels the controls have less sensitivity, giving you more time to perceive mistakes and correct them.

The higher the weather and performance factors, the more challenging the game, and the more points you are awarded for that event.

Ground or Airborne Start: Ground start means every event begins at takeoff and ends at landing. Airborne start means that all events start airborne, and all events but landing competitions can be finished airborne. Airborne starts allow beginners to try events without having to master takeoffs and landings. However, in addition to appropriate score adjustments for an airborne start, an extra 12% points penalty applies whenever you use an airborne start.

F3 - See Standings: If you press F3, you can view the competition standings so far. Pressing any key returns you to flight clearance.

F5 - See Hall of Fame: If you press F5, you can view the "record books". Pressing any key returns you to flight clearance.

Control Stick Fire Button exits the screen and begins your flight (once the controls are unlocked, see below). Don't press it until you're done making selections!

Digital Controls Lock

IMPORTANT: You must unlock the controls!

Your AcroJet has a sophisticated microelectronic controls lock. The lock will display a color (the color appears as a text message in most versions). YOU MUST RESPOND WITH THE CORRECT THREE-DIGIT LOCK CODE. These lock codes are listed alphabetically at the bottom of various pages throughout this manual.

Find the correct code, type the three digits, and press RETURN. If you do not enter the correct code, your AcroJet will not perform correctly.

For example, your AcroJet may display the lock color "Burgundy". You find the page that lists "Lock Color: Burgundy" at the bottom, and read across to find the code — it's 025. You type the digits 0, 2 and 5 in that order and press RETURN. Your AcroJet is now unlocked and fully functional.

Remember, codes are at the bottom of the page. You must match the color with the proper code number. Otherwise, your AcroJet will not perform correctly.

Control Stick Fire Button exits the screen. Don't press it until you're positive you have the correct lock code.

Lock Color Code: Azure

Unlock Code 459

Unlimited Judging

When each pilot finishes an unlimited event, the contestant's performance can be judged, just like real aerobatics. Contestants can judge each other, or a separate judge (or panel of judges) can watch all the contestants, each select a score, and then input their average score (real events use a panel of judges).

Type judging score: The judges give a score between 1.0 and 9.9. The lowest score 1.0, the highest 9.9.

If an event is not judged, enter 9.9 for each contestant.

If an event was timed and judged, do NOT judge the contestant's time. Comparative times are automatically included in scoring of all timed events. Judging is based purely on the quality of performance, never on duration.

Control Stick Fire Button exits the screen. Don't press it until you're sure the judging score is correct.

Scoring Recap

This appears after every contestant's flight, and shows the score for that event (including judging, if it was an unlimited event). If the competition is over, pressing any key will display the final standings. Otherwise, you have three options:

F5 - See Hall of Fame: This allows you to view the "record books". After viewing the Hall of Fame, pressing any key will return you to flight clearance.

Control Stick Fire Button press exits the screen. Press it when you're done.

Competition Standings

Here you can see the scores for all contestants in all events. This is particularly useful in the Pentathlon and Decathlon. Each contestant's scores are in separate columns. The contestant who just finished flying has his column highlighted.

In addition to contestant scores, at the far right you can see the scores of Major Bill. These are scores of a real USAF Fighter Pilot, to give you a point of reference and comparison.

If the competition is over, pressing any key displays the WGSP Hall of Fame. Did you get into the record books one of the World's Greatest Sport Pilots?

F5 - See Hall of Fame: This allows you to view the "record books". If the competition is over, this is the next screen anyway.

Control Stick Fire Button exits the screen. Press it when you're done.

Summary of Startup & Scoring Controls

Control Stick Up/Down: Moves highlight cursor up and down the screen.

Control Stick Left/Right: Selects/erases highlighted option.

Typing: Used to enter names or numbers in highlighted areas, finish the entry by pressing RETURN.

F3: View current Competition Standings; press Control Stick Fire Button to return.

F5: View WGSP Hall of Fame; press Control Stick Fire Button to return.

Control Stick Fire button: Accept all inputs as correct and continue.

CTRL C: Clears WGSP Hall of Fame (only available on that screen.)

RUNSTOP RESTORE: Erases all selections and restarts.

Lock Color Code: Beige

Unlock Code 741

ACROJET FLYING CONTROLS

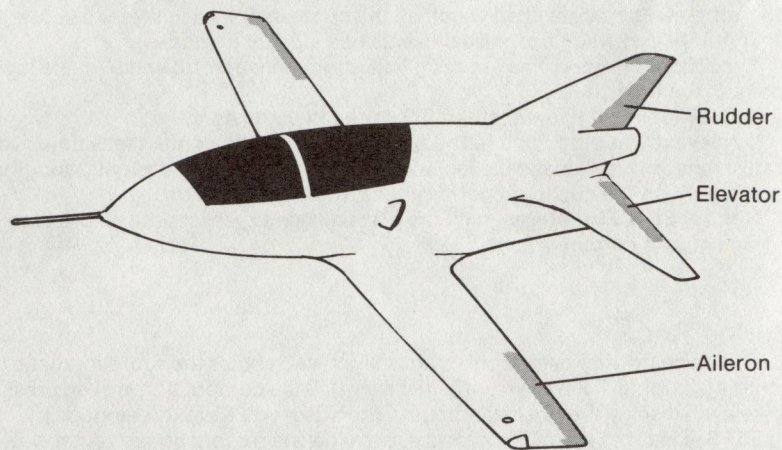

AcroJet Controls

Control Stick Forward: Dive. This lowers the elevators, which pushes the tail of your plane upward. In normal flight this results in a dive.

Control Stick Back: Climb. This raises the elevators, which pushes the tail of your plane downward. In normal flight this results in a climb.

Control Stick Left or Right: Bank. This deflects the ailerons, causing your plane to bank and turn in the appropriate direction.

Control Stick Button: Slip. Pressing the control stick button while you push the stick left or right banks the plane with "opposite rudder". The result can be a faster descent while you continue flying forward, or straight nose tracking during an aileron roll.

Viewing. The W,A,S and Z keys change your viewing direction. "W" shows the normal forward view, "A" shows the view to the left of the plane, "S" the view to the right, and "Z" the view to the rear.

0-9: Throttle. Press 0 to completely close your throttle, which turns off the engine. Press 1 through 9 to set your throttle, from lowest power (1) to highest (9). Higher power causes your plane to fly faster, but be careful your engine doesn't overheat (exceed an EGT reading of 700°C).

F: Flaps. Press F to change your flaps settings. Flaps can be either up (0°), partly lowered (20°), or completely lowered (40°). In general, flaps add lift and permit slower landing speeds.

L: Landing Gear. Press L to raise and lower your landing gear. Landing gear must be lowered for a safe landing, and raised for safe flying.

B: Landing Gear Brakes. Press B to brake your landing gear wheels. This slows you on the runway. This is especially valuable if you land too fast, or too far down the runway.

Space Bar: Speed Brakes. Press the space bar to extend and retract your speed brakes. When speed brakes are extended your airspeed slows significantly.

F1: Engine/Weather CRT. Press F1 to switch the left CRT between engine readout and weather information.

Software Controls

CTRL R: Hold down CTRL and press R to end the competition.

CTRL V: Volume Control - hold down CTRL and press V to turn the sound on and off.

RUNSTOP RESTORE: Hold down RUNSTOP and press RESTORE to reset the entire program to the start again (all records are blanked).

AcroJet Keyboard Controls (C-64)

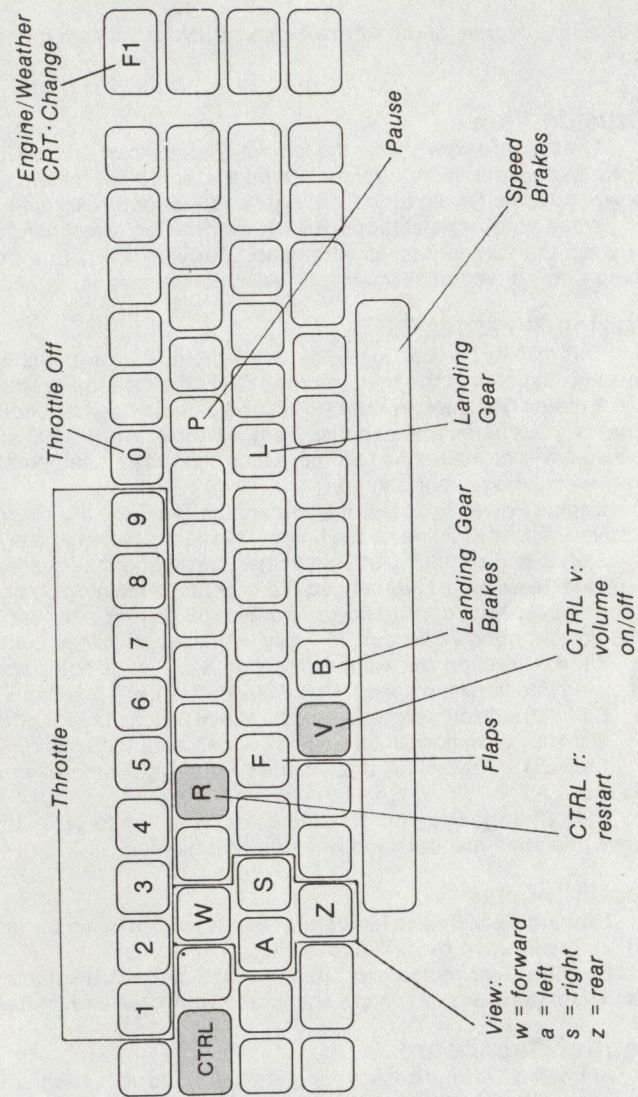

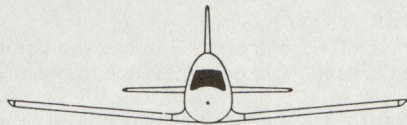

ACROJET COCKPIT INDICATORS

A detailed diagram of the AcroJet cockpit layout appears in the centerfold of this manual.

Outside View

The forward view shows the famous Thunderbird “in the slot” 3-D perspective — as if you were flying directly behind the AcroJet. The left, right, and rearward views show the terrain to the left, right and rear of the AcroJet, respectively.

When your AcroJet loops, it flies “over the top” and changes direction. At the very top the screen flashes white and your view shifts to a position behind the plane’s new direction. Remember, the screen flashes white when the view shifts.

Engine/Weather CRT

This display can be toggled between engine data and weather data. The key to press is indicated at the bottom of the CRT (the Change Prompt).

Exhaust Gas Temperature (EGT): Indicates in degrees centigrade the temperature of your jet engine exhaust. Temperatures over 650°C are dangerous, and should never be maintained for more than 5 minutes. A temperature over 700°C or more will damage your engine.

Engine Power: Indicates the percentage of engine thrust power. This changes with your throttle setting. A reading of 0% means the engine is off.

Speed Brakes: “S.BRAKE” indicates that speed brakes are slowing the plane.

Fuel Remaining: Number of gallons of fuel remaining on board. Your AcroJet has a fuel capacity of 50 gallons, and uses 38 gallons per hour at cruising speed. Fuel consumption varies considerably with your throttle setting.

Wind: Direction the wind is blowing *from*, as a compass heading. On the following line the wind speed is given in knots (1 kt = 1.136 mph).

Ceil: Altitude of the lowest clouds, above which the ground becomes invisible.

Vis: Maximum horizontal visibility underneath the ceiling.

Clock: This real-time clock shows your flight time in hours, minutes, and seconds.

CRT Change Prompt: This indicates what key to press to change the CRT between engine readouts and weather information.

Landing Gear

Landing Gear Brakes Indicator: This shows red when the landing gear brakes are on, green when the brakes are off.

Landing Gear Indicators: The upper indicators are lighted when the landing gear is up, the lower indicators are lighted when the landing gear is down.

Central Dashboard

Altimeter: This indicates your plane’s altitude above sealevel. The small hand indicates altitude in thousands of feet, the large hand indicates altitude in hundreds of feet.

Lock Color Code: Burgundy

Unlock Code 025

VVI (Vertical Velocity Indicator): This indicates the rate of altitude change, in thousands of feet per minute. The upper half of the indicator shows a positive vertical velocity (plane is gaining altitude), the bottom half shows a negative vertical velocity (plane is losing altitude). For example, a reading of .5 on the bottom part of the indicator means your plane is losing altitude at 500 feet per minute.

Airspeed Indicator: This shows the airspeed in miles per hour. Redline airspeed is 346 mph (a higher airspeed causes uncontrolled flight, as your controls are stalled and ineffective).

Flaps Indicator: This shows whether flaps are up (0°), half lowered (20°), or fully lowered (40°). Planes normally fly with flaps up because speeds over 110 mph can damage extended flaps.

Magnetic Compass: This indicates the direction you are flying.

Compass Heading Indicator: This also indicates the direction of flight, but with greater precision. A heading of 0/360 is North, 90 is East, 180 is South, and 270 is West.

TO (Airfield Beacon Heading): This readout shows the compass heading to fly to reach the airfield. Turning and flying the heading indicated takes you directly to the airfield. This instrument is not available in some versions of AcroJet.

Aerobatics CRT

This computerized display dynamically updates a map of the event and your position, as well as elapsed time.

Course Map: This is a miniature map of the event, showing the pylons, ribbons and airstrip. The dotted line indicates the course you should fly, the flashing dot indicates your current position. If you are outside of the aerobatics area the flashing dot for your position becomes inaccurate.

Event Timer: The minutes and seconds clock beneath the map shows the time elapsed in the event.

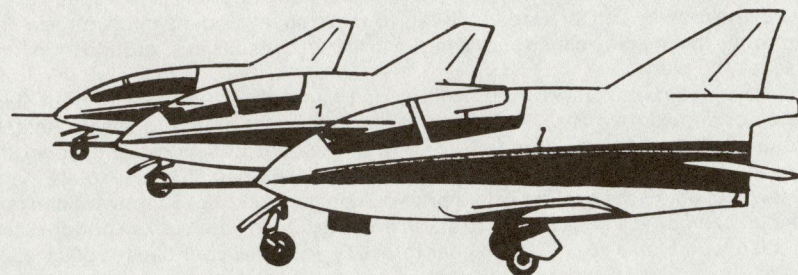

Lock Color Code: Crimson

Unlock Code 817

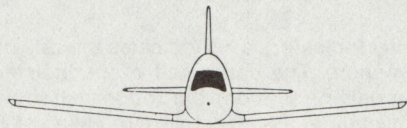

BASIC MANEUVERS

Climbing & Diving

Nose Down by pushing forward on the control stick. Your AcroJet will start to dive because the elevators are angled downward, pushing the tail up.

Nose Up by pulling back on the control stick ("backpressure"). Your AcroJet will start to climb because the elevators are angled upward, pushing the tail down.

Turning

Bank Left by pushing the stick left. Your AcroJet will begin a left turn. Ailerons and rudders are automatically coordinated at your control stick.

Bank Right by pushing the stick right. Your AcroJet will bank into a right turn. Ailerons and rudders are automatically coordinated at your control stick.

Slips & Rolls

Slips allow you to lose altitude faster. Normally this requires careful use of rudder and ailerons. Your AcroJet control stick button automatically balances rudders and ailerons in "uncoordinated flight", making slips easy to perform.

Slip Left by pressing the joystick button while pushing the stick left. Your AcroJet rolls left and begins losing altitude.

Slip Right by pressing the joystick button while pushing the stick right. Your AcroJet rolls right and begins losing altitude.

Rolls also use "uncoordinated flight" techniques. To roll with your nose tracking straight ahead, press the joystick button while pushing the stick either right or left. To maintain level flight while rolling you need to adjust your angle of attack (see the section on Aerodynamics for details).

An Easy Takeoff

First warm up your engine by setting minimum thrust (press 1). Next, make sure you have plenty of runway straight ahead. If you don't, taxi at low speed to the end of the runway and turn around. Keep your taxi speed under 25mph, otherwise a turn while taxiing may cause your wingtip to lift. This results in a "ground loop" and crashes the plane.

Now begin your takeoff by setting "half flaps" (press F once — your flaps indicator should read 20°). Next open the throttle to maximum (press 9). Release the landing gear brakes (press B) and your AcroJet begins moving down the runway. Watch your airspeed indicator. When it reaches 65 mph "rotate" your nosewheel up off the ground with a brief pull on the stick. At 75 mph you can take off: pull back on the stick briefly to start climbing. Once you're a few hundred feet off the ground raise your landing gear (press L) and raise your flaps to 0° (press F twice).

When you've reached the altitude you wish, push the stick forward until the plane levels out and the VVI (Vertical Velocity Indicator) reads zero (0). Reduce your throttle to cruising power (press 6).

An Easy Landing

Landing is much harder than takeoff. The following is a simple landing approach suitable for beginners:

First, set up for a "Final" approach by flying northward toward the runway. Fly at 750' and 100 mph speed with half flaps (flaps at 20°) and landing gear down. Now begin your gliding descent, which is flown at a 3-5° angle downward at 85mph. Cut your engine power by setting the throttle to 3 or 4 (press that key) and push the stick forward just a TINY bit. Control your descent by adjusting your throttle — more power will slow the descent, less power will increase your descent. You may find the speed brakes useful (press the space bar). The most common mistake when landing is constant fiddling with the joystick — the plane will fly itself if you let it!

As you get over the runway at low altitude level out and cut your speed further. Your goal is to touchdown the two rear wheels at 75 mph and nearly zero descent velocity. Hitting the runway with a descent velocity greater than .5 thousand feet/minute (.5 down on your VVI) can cause damage or a crash. Once you've touched down cut the power (if you haven't already) and hit the landing gear brakes (press B).



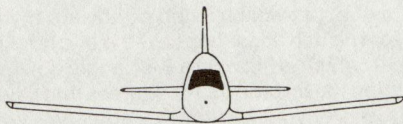

AERODYNAMICS & BASIC FLIGHT

This discussion of aerodynamics and flight is deliberately simplified to help a beginning aviator grasp the essentials of flight. The details of flight physics have a many other factors involved. To this day scientists debate aspects of flight and aerodynamics.

Staying Airborne

Lift: Your BD-5J defies gravity and flies because enough air is passing across the wings to create a pressure differential between the air above the wing (low pressure) and the air beneath the wing (high pressure). The high pressure beneath the wing forces the plane upwards ("lifts" the plane), keeping you airborne.

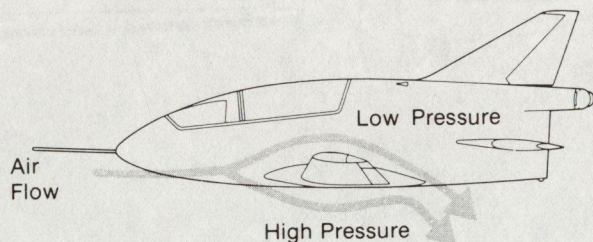
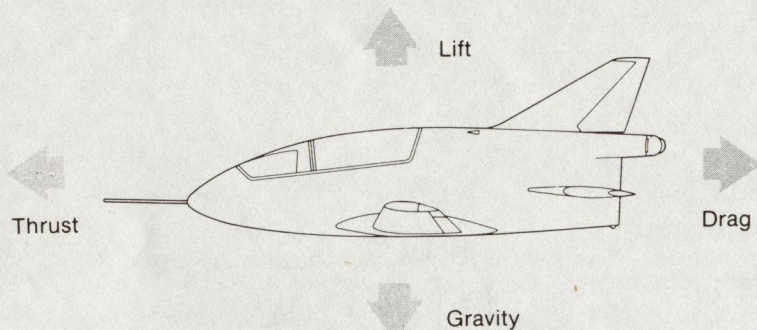

Pitch: This common term refers to the angle your plane points up or down, relative to level flight. A plane diving has pitch down of 1° to 90° ; climbing it has a pitch up of 1° to 90° . To change your pitch, simply push the stick forward or pull it back.

Angle of Attack: Air flows over the wings because you're moving forward. The faster you travel, the greater the airflow, and the greater the lift. This means that a plane at high speeds generates more lift, while a plane moving at lower speeds generates less lift. Therefore, to maintain level flight a pilot needs to make fine adjustments to the amount of lift generated. He does this by tilting the wings slightly upward or downward in relation to the direction of flight. This "tilt" is termed the "angle of attack."

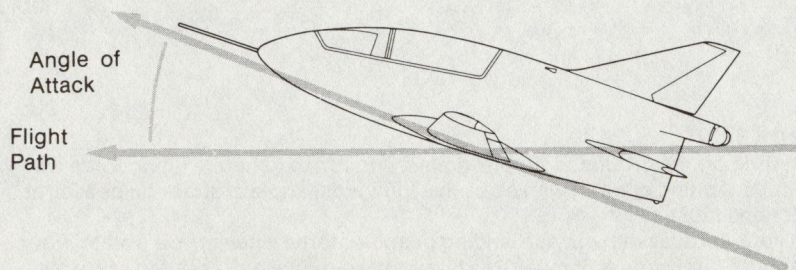

At slow speeds a pilot uses a large angle of attack to maintain level flight. At high speeds a pilot uses a small angle of attack. When flying your AcroJet, if the plane appears to be flying level but the VVI indicates you are gaining or losing altitude, you need to adjust your angle of attack. Briefly push the stick forward or back (i.e., pitch down or up) to change your angle of attack.

Turning

Aircraft turns are greatly misunderstood. Turns are NOT accomplished with the rudder. Instead, the ailerons are used to tilt the wings left or right. The lifting force of the wings is now working sideways as well as straight down. The sideways component of the force is the primary cause of the turn. Therefore, the further you bank the wings, the tighter you turn. However, the further you bank, the less lift you generate. Therefore, to make a tight turn without losing altitude you need to add some "backpressure" (pull back on the stick).

Pilots sometimes use a small amount of rudder during turns for fine adjustments. However, rudder without ailerons simply slews the plane sideways without changing direction. Your AcroJet controls have simplified the aileron-rudder coordination problem by automatically including fine rudder corrections under computer control. These are proportional to the degree of bank you demand.

Slips: Do not confuse banking turns with slips. In a slip "opposite rudder" counteracts the turning force of the bank, causing the plane to continue going forward. Pressing the control stick button produces this "uncoordinated" flight (rudder and ailerons are no longer coordinated for a banking turn). However, the banked wings still result in less lift. Therefore, the plane loses altitude faster — the steeper you slip, the greater your rate of descent.

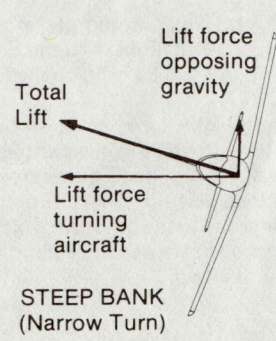
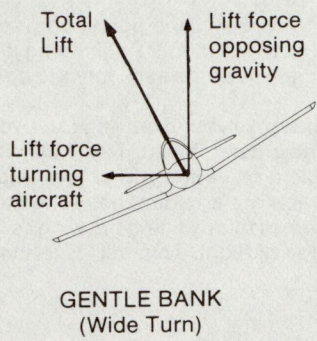

Takeoffs

Getting off the ground is simple: go fast enough to generate lifting force with your wings. Adding extra lift with a positive (upwards) angle of attack helps a lot, as do half flaps (20°).

In your AcroJet with tricycle landing gear (i.e., three wheels) you "rotate" your nose about 5° upwards at 65mph. This tilts your wings upward, creating a favorable angle of attack. At 70mph to 75mph (depending on flaps setting) you have enough lift to become airborne. The nose can be safely pointed further upward (normally to 10°).

Raise your landing gear immediately after takeoff. The AcroJet has a particularly nasty instability when it's landing gear are down — get them up as fast as you can. Note that if you turn during takeoff you climb more slowly, since a banking plane generates less lift.

Landings

A safe landing is much more complex than a safe takeoff. A standard landing approach for a small airstrip has three phases: the "downwind" leg, the "base" leg, and the "final".

The "downwind" leg allows you to look out the side of the aircraft toward the airstrip and align yourself. It also gives you a chance to reach the proper altitude and speed (if you're flying an airport landing pattern you should already be at the correct altitude and speed). In your AcroJet a standard landing pattern for a small airfield starts with a "downwind" leg at 1,000' altitude and at 125 mph. A conservative "downwind" leg should put you a considerable distance to the side of the airport (giving you a nice, long base leg). Traditionally you set half flaps (lower them to 20°) and lower your landing gear at the end of the downwind leg. However, due to the AcroJet's gear-down instability, you may wish to wait until final before lowering the landing gear.

Start your "base" leg with a 90° turn toward the airport. On this leg you'll cut your speed to 100 mph and descend to 750'. When you're almost perpendicular to the airport (look to the left to check your position) it's time to turn another 90° onto the final.

On the "final" line up on the runway, pitch down onto a 3° to 5° glide descent, and lower your speed to 85mph. Using your speed brakes to reduce speed is a good

idea (retracting the brakes again will give you instant acceleration, should you need it). Once on the glide path use the throttle to adjust your rate of descent.

Touchdown speed should be 75 mph with the standard 20° flap setting. A no-flaps landing has a touchdown speed of 80mph, while a full 40° flaps landing (useful when landing over obstacles, or in a short distance) should be at 70 mph. Vertical velocity downward in excess of 500 ft/min (.5 on the VVI gauge) risks damage to the plane, and velocity downward in excess of 850 ft/min almost invariably causes a crash. When landing, touch down the two rear wheels first, then the nose wheel. A three point-landing tends to cause skipping and hopping (porpoising) down the runway!

This slow, high altitude approach is the safest way to land. Altitude is a valuable commodity that insures your flying safety. If you have too much altitude, you can always use a slip downward. If things go badly, increase throttle and climb back up to 1000' for another downwind leg.

Low altitude landings are much more dangerous. It's easy to come in too slow or too low, and therefore need more throttle on the final to keep your speed or altitude. This is very dangerous - if your engine failed, you wouldn't be able to get the necessary speed or altitude, resulting in a crash short of the runway! Furthermore, remember that any power increase will close (turn off) speed brakes.

Flaps must be used carefully during takeoff and landing. First, extending flaps when flying over 110 mph can damage them - don't use them at maneuvering speeds! Half (20°) flaps with a fairly small angle of attack add lift, and can be valuable whenever you're flying slow and fairly level (such as during a takeoff or landing). Full (40°) flaps add even more lift, but impose significant extra drag. Your plane tends to "ballon" upward, then slow and drop again.

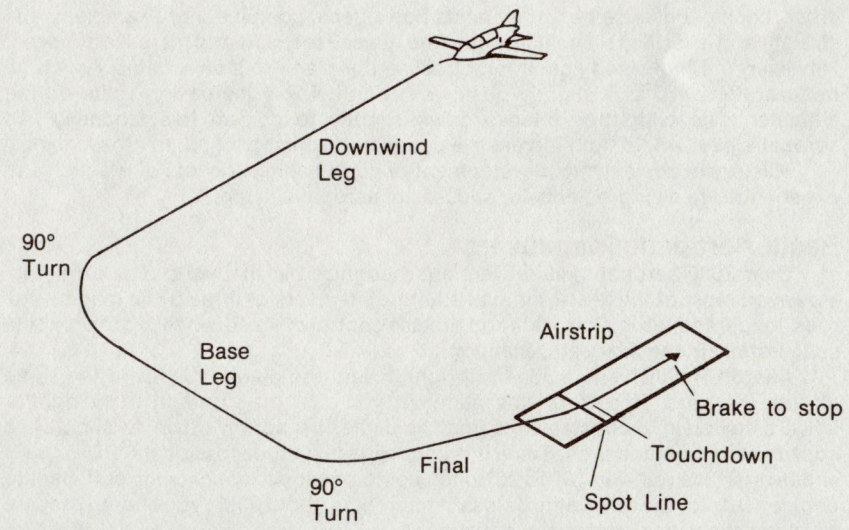



AEROBATIC FLYING

Aerobatic flying is the ultimate test of skill, courage and concentration for today's sport aviation pilot. An aerobatic pilot needs extensive knowledge of aeronautics, a precise grasp of his aircraft's capabilities, and the capacity to coordinate and control the plane while bombarded with a mass of confusing information from instruments, eyes, and his body.

As an aerobatic pilot you must combine the basic flight maneuvers of climbing, diving and turning in complex patterns while maintaining precise control of your plane. The fundamental skill required is the "crosscheck".

Crosscheck is the ability to receive, digest and respond to all incoming information. It is the feedback loop that enables you to make the right control adjustment (such as changing airspeed, altitude, attitude, etc.) to accomplish the desired result.

For example, straight and level flight at a prescribed airspeed requires you to look outside to visually see your pitch up or down, then to crosscheck to attitude indicator, airspeed indicator, vertical velocity indicator and altimeter to confirm your current situation. You may then change throttle setting and/or pitch (i.e., dive or climb), and crosscheck to observe the results. Novice pilots vary one control at a time, then crosscheck.

Aerobatic flying demands that the pilot understand how different controls interact. The pilot is often making changes with a variety of controls before he crosschecks - because he understands how effects combine. For example, in the straight and level flight, a novice might find himself too slow and increase airspeed. However, the increased speed might cause the plane to slowly climb, which he notices afterward as a slightly positive VVI and slowly increasing value on the altimeter. The pilot then pitches down slightly to correct this tendency. An aerobatic pilot would both increase airspeed and adjust pitch, then crosscheck.

Mastery of basic flying, development of good habits, and lots of practice and experience are all ingredients for successful aerobatic flying.

Basic Aerobatic Maneuvers

Over 8000 aerobatic maneuvers are recognized in the world of sport flying. However, most of these are variations and refinements of three basic maneuvers: rolls, loops, and turns. Solid skill and precise control of these is needed to compete successfully in the AcroJet Decathlon.

Aileron Roll: This is a 360° roll right or left: the plane finishes in the same attitude it started. To perform this maneuver you push the stick fully to the right or left. To maintain a constant heading, hold the fire button down to simulate a coordinated, unloaded roll. Since this can result in altitude loss on the BD-5J, you should start the roll with 10° to 20° pitch up, to provide a rate of climb sufficient to compensate for the roll's altitude loss. After rolling about 330°, you should prepare to center the wings level to the horizon.

Loop: This is the basic "over the top" maneuver. The plane's nose is raised to vertical and past it, resulting in inverted flight in the opposite direction. Then the

plane flies a downward arc, returning to the position where it started. Since a loop begins with a climb to vertical, it must be started with sufficient speed — in your AcroJet at least 200 mph, preferably 250 mph to 300 mph.

In the first part of the loop you can simply "honk back" on the stick to start your nose up. However, it is wise to extend this stage somewhat and gain extra altitude upward, since you'll be coming down the other side of the loop very fast! Do this by releasing the stick momentarily at 40° pitch, then start pulling back after you have gained a sufficiently safe altitude (but don't let your speed fall too low, otherwise you could stall at the top of the loop). As you approach the top of the loop release the stick a little to prevent an inverted stall.

Once you're over the top and coming back down pull back hard, early, to get a majority of the turn finished quickly, then pull lightly as needed to control the altitude of your final pullout. Notice that the back side of the loop includes a long, arcing power dive — this can happen very fast, and cost you lots of altitude. The most common error in looping is simply holding the stick back, with no adjustments for speed reduction and insufficient altitude at the top. The most fatal error is underestimating altitude loss coming down the back side of the loop.

Begin learning loops by flying large, high ones. Work hard to finish your loop at the same altitude and heading you started. Next, you can gradually narrow the diameter until you're flying tight "Tiger Fighter Pilot" loops. Finally, you can practice loops starting and ending at low altitude — the most dangerous of all.

Immelmann Turn: This turn, originally conceived by a WWI German fighter pilot, is a half loop followed by a half roll. The maneuver begins with the upside of the loop, flown until you are flying level and inverted, on a heading 180° from your starting direction. Next you roll either right or left 180° back to level flight. Depending on the tightness of the loop, an Immelman will add about 1500' to 2000' to your altitude.

Split-S Turn: This turn is the downside counterpart of the Immelmann. You start with a half roll to inverted position, then perform the downside of the loop until you are flying level on a heading 180° from your starting direction. You will lose considerable altitude during this maneuver.

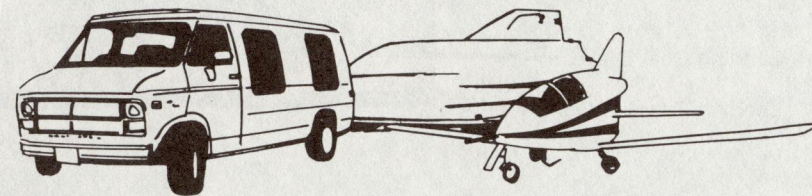

BD-5J ACROJET COCKPIT LAYOUT

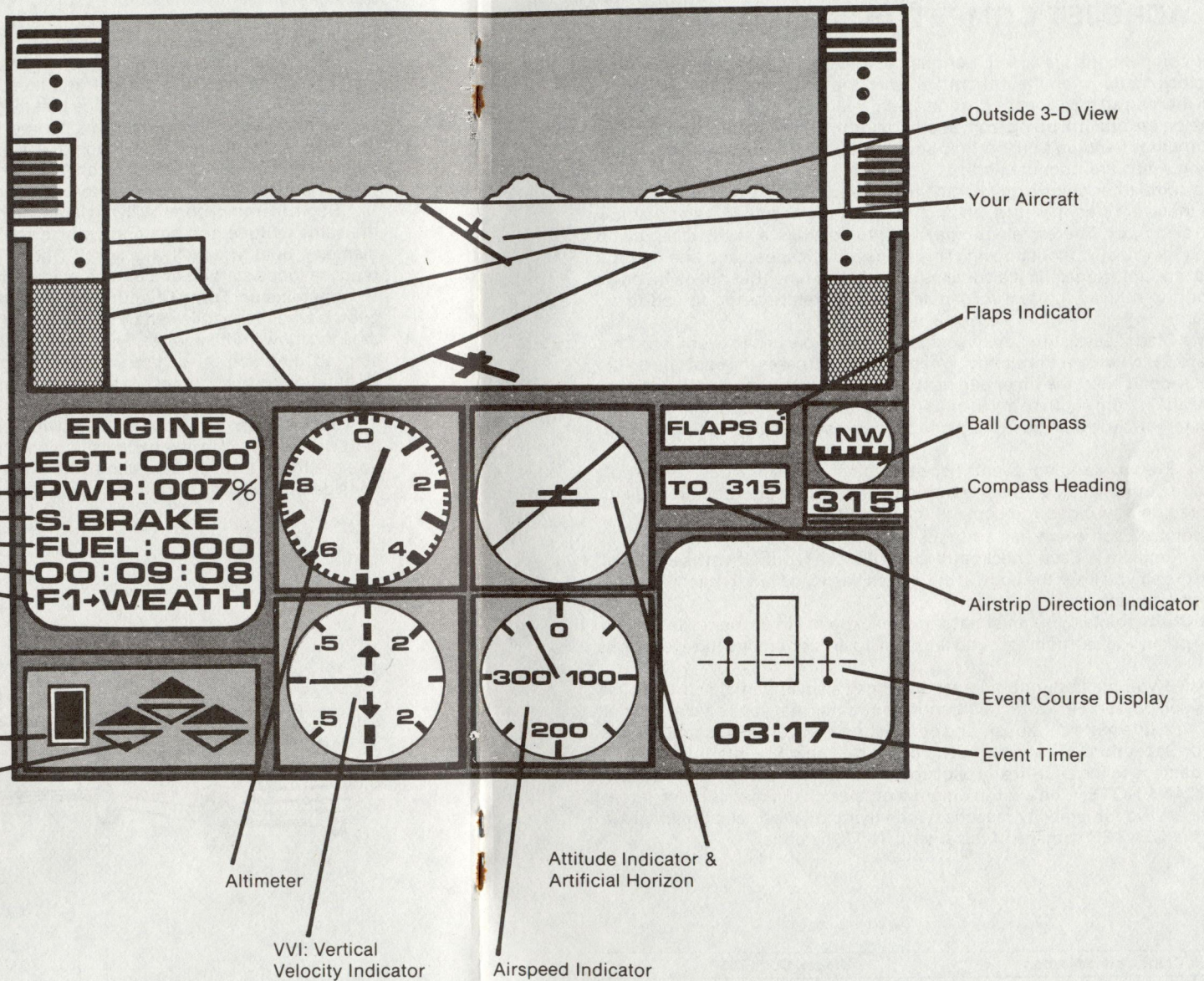

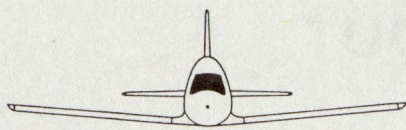

ACROJET COMPETITION EVENTS

All AcroJet competitions are timed. Serious competitors should select a ground start. The clock starts when their aircraft crosses the spot line on the runway. It stops when the aircraft stops on the ground again. A landing must include crossing the spot line on the airstrip, going from south to north. This means all landings are headwind landings (landing from north to south results in a tailwind landing, since the prevailing winds are from the north).

A good competitor plans a quick route from takeoff to the event, and another route from the event's endpoint to landing. Many of the events leave you at low altitude travelling fast. Therefore, you may wish to end with a short, steep climb before flying the "final" to touchdown. This helps reduce speed and line up for a good approach. Unfortunately, it also takes a little extra time (but not as much as approaching the runway too fast for landing, and therefore being forced to go around again!).

Airborne Starts: Less ambitious flyers are allowed to start an event airborne. You begin at 250' flying over the airstrip. When the plane crosses the spot line on the strip (a split second later) the timer begins. When the event is finished, flying over the spot line again from south to north ends the event. Since the spot line is a small and difficult target, fly low and use the plane shadow as an aid in crossing the spot line.

Landing Events: Landing events (spot landing and simulated flame-out) always require you to finish on the ground, even if you start airborne. In addition you are scored on how close you come to the spot line.

Checkpoints: Each event has a number of "checkpoints" you must pass to successfully complete it. Each checkpoint is listed in the requirements section for the event. In the air you'll see the edge of the screen flash blue briefly each time you complete a checkpoint.

Missed Checkpoints: You must pass the checkpoints in proper order. If you miss a checkpoint, you can come around and try it again, continuing the event from there.

Crashes: If you crash during an event, you get a small partial score for the checkpoints you passed. However, this amount is so small that you're always better served by flying a little more cautiously and completing the event. If you crash in the Pentathlon or Decathlon, you are allowed to fly the remaining events. In real life, of course, the damage to the aircraft and pilot could prohibit any further competition.

IMPORTANT NOTE: The airstrip diagram on the cockpit map is much larger than the real airstrip for legibility reasons. When flying by the cockpit map, guide yourself by the CENTER spotline of the airstrip, NOT the edges.

Pylon Race

Difficulty Factor: 1.0.

Requirements: After leaving the airstrip, the contestant must pass outside of the pylons in order: SE pylon first, then SW pylon, NW pylon, NE pylon, and finally the SE pylon again; then the contestant must return to the airstrip.

Remarks: This event is a pure air-race. To be successful, you must plan how to fly the minimum distance at the maximum speed. This means turning as close to the pylons as possible, and flying very low to the ground (gaining altitude costs both time and speed). Pilots typically fly this entire event with full throttle. Be sure to watch your EGT — if the temperature passes 700° you'll lose your engine! Just before this happens a good pilot will cut his throttle (to 7) briefly to cool the engine, then apply full throttle again.

PYLON RACE

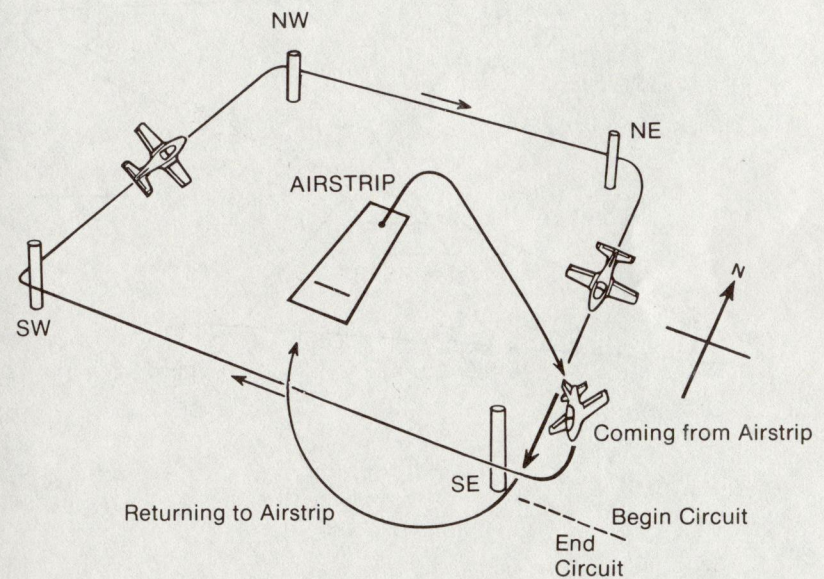

Lock Color Code: Maroon

Unlock Code 751

Lock Color Code: Olive

Unlock Code 428

Slalom Race

Difficulty Factor: 1.5.

Requirements: After leaving the airstrip, the contestant must fly around the pylons from north to south in order: NW first, then NE, SW, SE, and NW again; then the contestant must return to the airstrip.

Remarks: This event is another air-race, but requires much more practice. It's easy to pass the wrong side of a pylon, or become disoriented by a tight turn and fly to the wrong pylon. If you miss a pylon, you can always circle around and pass it correctly, then continue. Good competitors plan their heading for each leg of the flight before the event.

SLALOM RACE

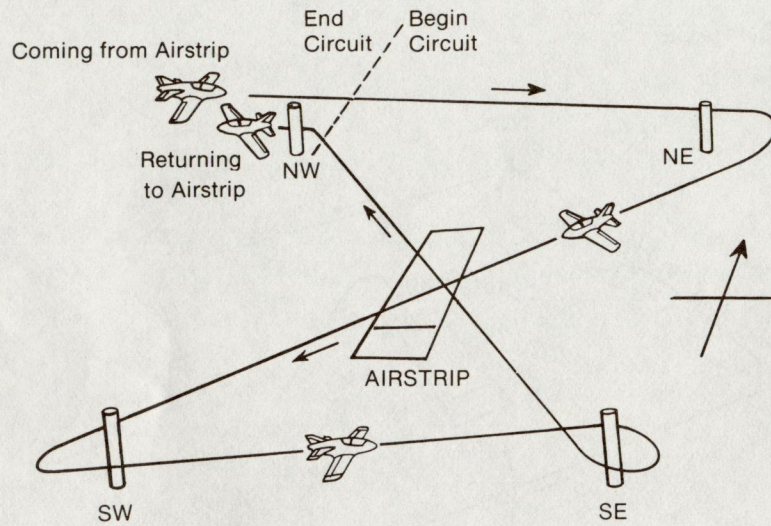

Lock Color Code: Ocher

Unlock Code 847

Ribbon Cut

Difficulty Factor: 1.7.

Requirements: After leaving the airstrip, the contestant must cut both 3" ribbons; then the contestant must return to the airstrip. Ribbons need not be cut in any particular order, nor from any specific direction.

Remarks: This is a traditional and famous event. It requires precise low-level flying to reach the right altitude for the cut while plotting a course that avoids crashing into a pole. The secret to this event is planning which direction to approach the ribbon, the turn between the cuts, and how to land quickly after the final cut.

RIBBON CUT

(Can be flown in either direction)
(Ribbons can be cut in any order)

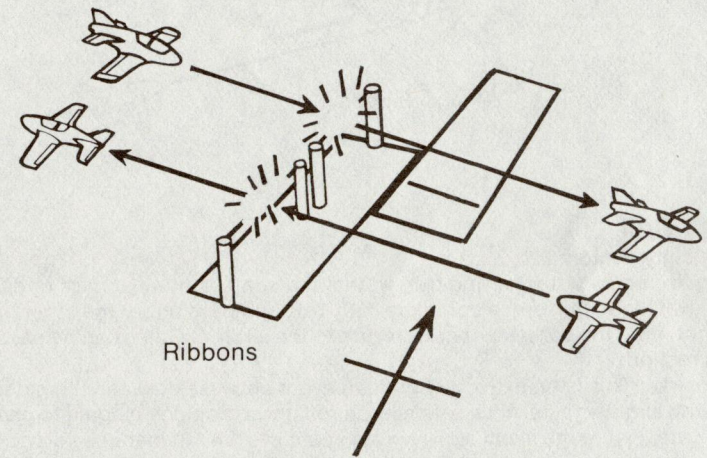

Lock Color Code: Peach

Unlock Code 384

Inverted Ribbon Cut

Difficulty Factor: 2.4.

Requirements: After leaving the airstrip, the contestant must cut both 3" ribbons while flying inverted; then the contestant must return to the airstrip. Ribbons need not be cut in any particular order, nor from any specific direction.

Remarks: This event seems the same as the regular ribbon cut, but appearances are deceiving. Inverted flying presents a special challenge. Pitch control movements (climbing and diving) are reversed. Once competitors master inverted flying, times at the ribbon even out. Success then comes to the pilot who best manages the normal-inverted transitions quickly. There is more than one way to get quickly from takeoff to inverted flight, and then from inverted flight to landing.

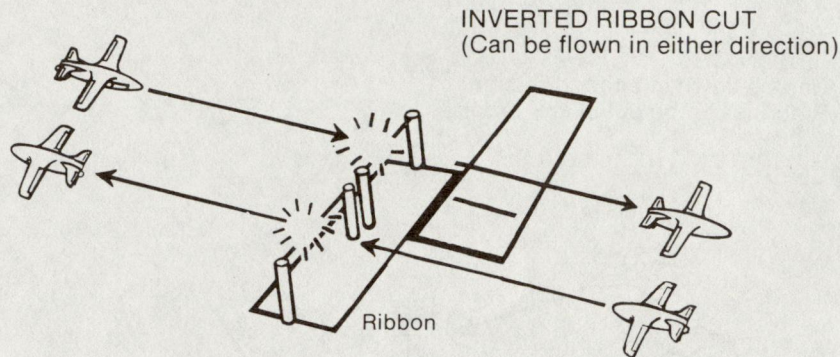

Ribbon Roll

Difficulty Factor: 2.2.

Requirements: After leaving the airstrip, the contestant must pass under one gate in level flight, perform a complete 360° roll, and pass under the other gate in level flight; then the contestant must return to the airstrip. Gates can be passed in either direction.

Remarks: This is an extremely difficult event because between the gates you must climb slightly to permit a safe aileron roll, then drop down again to pass the second gate. Flying the event slowly gives you more time to manage your roll and diving to the second gate, but flying too slowly can be fatal during the roll itself.

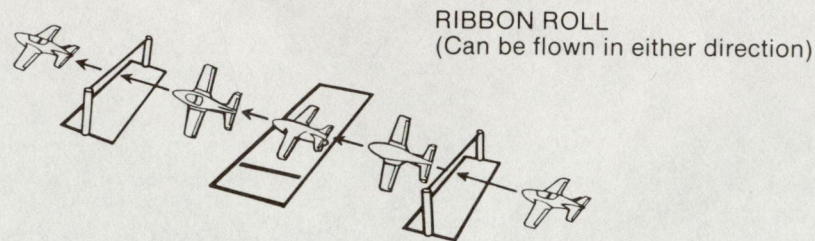

Under Ribbon Race

Difficulty Factor: 2.0.

Requirements: After leaving the airstrip, the contestant must pass under the three gates in proper order: first the NE gate from east to west, then the W gate from west to east, and finally the SE gate from east to west; then the contestant must return to the airstrip. The contestant must pass UNDER the gate ribbon - cutting the ribbon is an unsuccessful pass.

Remarks: This is the toughest AcroJet competition air race, since the desire to turn tightly through the gates must be tempered with the low altitude flown and the danger of a wingtip catching the ribbon if you pass through the gate with a steep bank. Success comes with finishing your turns before the gates, which means flying a longer straight-path between gates. Some contestants have experimented with half-loops instead of conventional turns, since it is entirely legal to fly the gates inverted.

UNDER RIBBON RACE

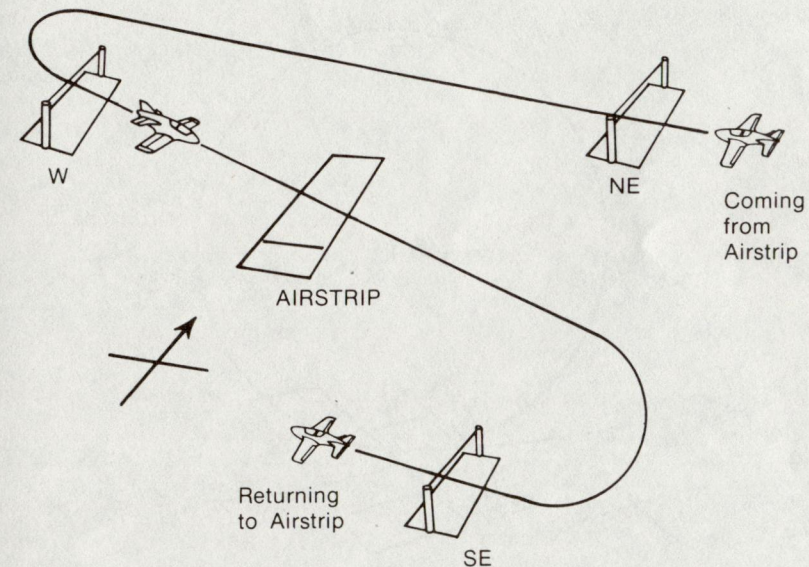

Lock Color Code: Rose

Unlock Code 162

Lock Color Code: Scarlet

Unlock Code 630

Loop

Difficulty Factor: 2.5.

Requirements: After leaving the airstrip, the contestant must fly through the gate, do a loop over the gate, and fly through the gate again; then the contestant must return to the airstrip.

Remarks: Normally sport pilots perform loops starting at 10,000', so they have room for error. Before attempting this event at competition levels, practice loops at a higher altitude, and master looping back to the same altitude. See the section on aerobatic flying for a detailed discussion of how to control a loop, including how to use joystick backpressure properly.

Survival and success in this event requires precise altitude control. Your safety margin can be increased by making the initial gate pass at more than 250 mph, and then climb to a very high altitude (5,000' or more) on the upside of the loop. Before you begin the downside turn extend the loop outward while flying inverted (i.e., don't drop the nose too fast). this will give you plenty of room after you come around to line up on the gate for the final pass. Later you can work on narrowing the size of the loop and improving your time.

LOOP

(Can be flown in either direction)

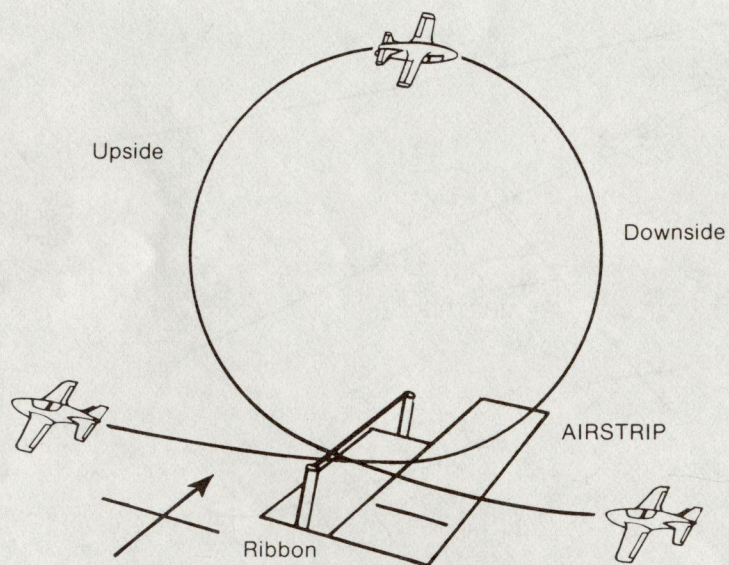

Lock Color Code: Sienna

Unlock Code 974

Spot Landing

Difficulty Factor: 1.8.

Requirements: After leaving the airstrip, the contestant must climb to at least 2,000', and land again on the airstrip from south to north. Scoring is based on where the wheels touch the runway. In a perfect score the wheels first touch at the spot line. There is a points penalty for first touching further north, and a double penalty for first touching further south. Note that the plane will invariably roll after the touch point, as it brakes to a stop. The final stopping point has NO effect on the score, provided the plane remains on the runway.

Remarks: This event requires precise control of a landing from 2,000', nothing more. Refresh your memory of landing techniques, described on page 16 and 17.

SPOT LANDING

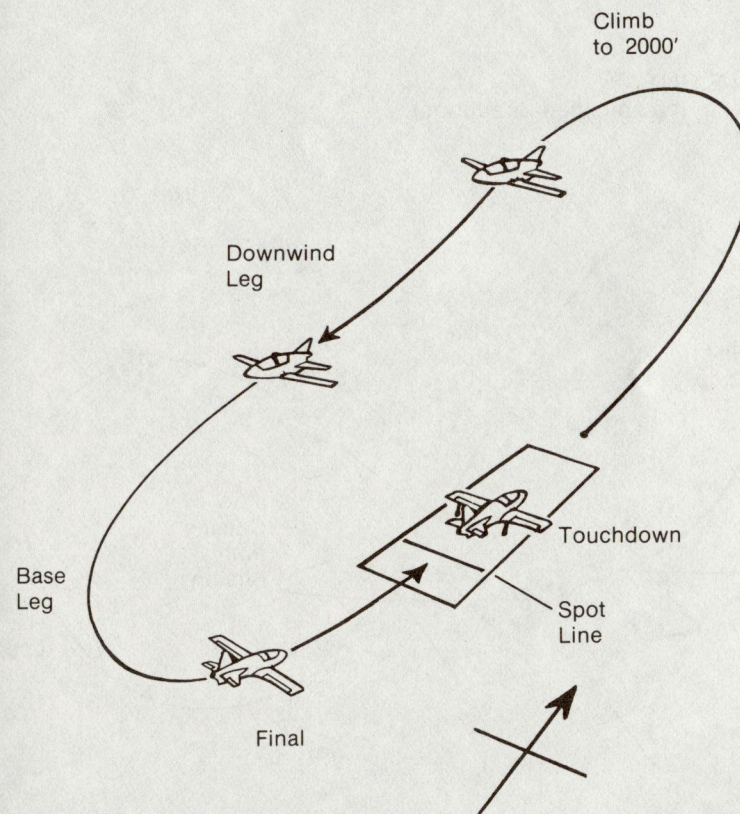

Lock Color Code: Tangerine

Unlock Code 913

Cuban Eight

Difficulty Factor: 3.0.

Requirements: After leaving the airstrip, the contestant must fly west through the west gate, half loop to cross above the gate, half roll on the descent to fly through the east gate, half loop to cross above that gate, and conclude with a half roll to fly west through the west gate again; then the contestant must return to the airstrip.

Remarks: This very difficult aerobatic maneuver requires absolute mastery of loops. As in a normal loop, descend through the first gate at high speed. After passing the gate you may wish to continue level for a distance before starting the loop. Once you're inverted at the top of the loop only drop the nose 10° to 20° toward the downside and begin your roll as you descend toward the second gate. Repeat the process after passing the second gate: again, level flight after passing the gate but before you start the second loop, can be valuable. Once you've mastered the event with wide loops you can work on beginning them sooner after you pass a gate.

CUBAN EIGHT (Must fly in the specified directions)

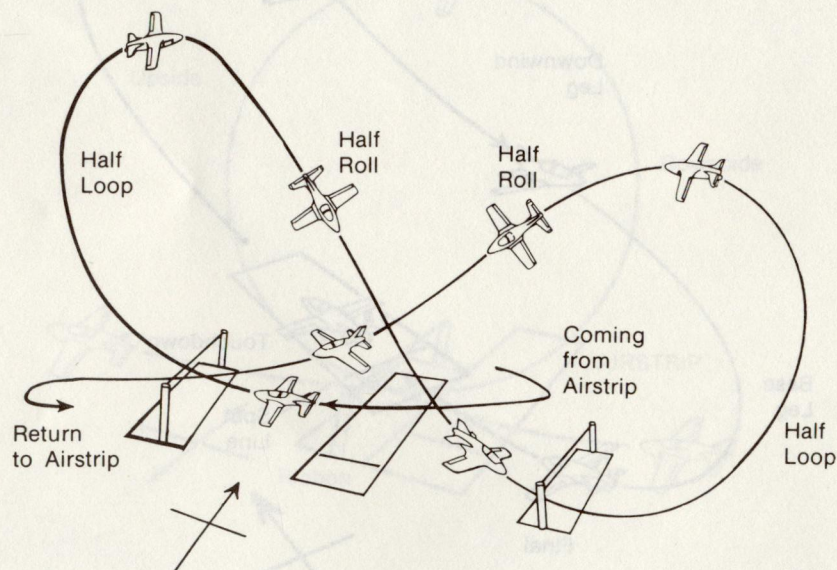

Lock Color Code: Turquoise

Unlock Code 290

Flameout Landing

Difficulty Factor: 2.0.

Requirements: After leaving the airstrip, the contestant must climb to at least 2000', set the engine to idle (press 0) *while over the airstrip heading north*, and glide to a landing on the airstrip. Landing requirements and scoring are the same as the Spot Landing, except that *any* use of the engine after it is turned off results in a very low score.

Remarks: An unpowered landing is similar to a regular landing. The point 2000' heading north over the airstrip is termed the "High Key". From here you spiral down 180° to the "Low Key" position. Low Key is normally about 1000' altitude, from which you make another 180° "Base Turn" toward the runway and land.

You control your altitude loss from High Key to Low Key by the width of your turn - the wider the turn, the longer it takes to reach the low key, and the more altitude you will lose.

The simulated flame-out (SFO) is more than just an aerobatic event — it's also an important skill for any sport pilot. During a pilot's flying career, it is quite likely that he will suffer an engine failure and need this skill to put his aircraft down safely in the nearest field or roadway.

FLAME-OUT LANDING

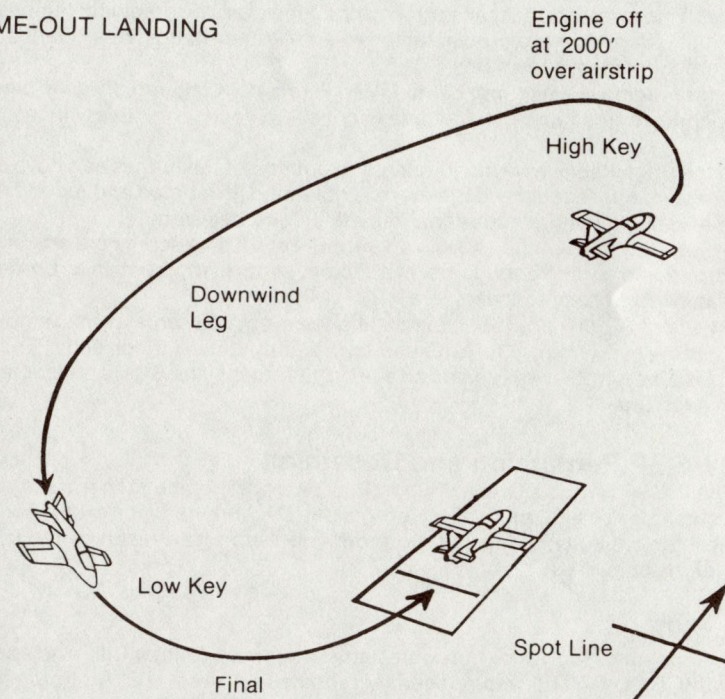

Lock Color Code: Umber

Unlock Code 578

The Unlimited

This event allows you to select your own course from the six available (see pg. 5). You decide what race or aerobatic maneuvers are required. You may want to sketch the event so everyone understands what's involved.

This means you can decide what aerobatics and/or racing paths are required. You decide the difficulty factor for the event too (select a value between 1.0 and 3.0, inclusive). The event can be timed or untimed, as you wish.

In real aerobatic competitions judges decide how well a pilot performed his maneuvers. In the unlimited you and your friends can judge each other, rating performance on a scale from 1.0 (the lowest possible score) to 9.9 (a perfect score). In an event that is timed but not judged, always give contestants a judging score of 9.9. Note that an event can be both timed and judged if you wish.

If you start an unlimited event airborne, any time you cross the spot line from south to north during the event, it will immediately end. Therefore, we recommend you do not begin unlimited events airborne, but instead on the ground.

Scoring

In all events a pilot is awarded a small consolation score for flying it correctly and finishing intact. You get a higher score for completing more difficult events. Additional bonuses are added for flying in more difficult weather conditions, and flying with more realistic aircraft performance. However, the dominant factor going into a high score (are the crucial factor when all other things are equal) is time. There are, of course, exceptions.

In the landing events (Spot Landing and Flame-out Landing) distance between the touchdown point and the spot line is critical to your score. Every inch counts here.

In the unlimited event with judging, the opinion of the judges can have a very significant effect, especially if the event is not timed. In a timed and judged event, the timer is slightly more important than the judges' decision.

Finally, in any event flown from an airborne start, time scores are adjusted for the starting and ending conditions. In addition, pilots flying from an airborne start suffer an extra penalty to their score.

If you crash or land without completing the event you score a small amount. If you fly the event wrong you can keep trying until you do it correctly. The only penalty is time lost. However, keep an eye on your fuel — the BD-5J consumes fuel like an Arab Sheik!

The WGSP Pentathlon and Decathlon

The WGSP (World's Greatest Sport Pilot) AcroJet competition is a sum of any five events (the Pentathlon) or all ten events (the Decathlon). Since event scores are adjusted for difficulty, flying the more difficult events can result in the highest Pentathlon score.

Major Bill

In addition to scores for the contestants, a score for "Major Bill" also appears. Major Bill is a U.S. Air Force Academy graduate and a real U.S. Air Force fighter pilot, as well as being the President of MicroProse. Naturally, he loves MicroProse flight simulators and is happy to fly with you anytime. The scores you see represent his better performances in each event. How do you stack up against someone with 3000+ hours in hot military aircraft?

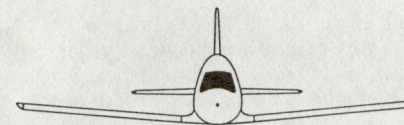

THE BD-5J ACROJET DESIGN

The BD-5J Design

The BD-5J is a very small, very fast, very high performance plane well suited to aerobatic and stunt flying. It is probably the smallest, least expensive aerobatic jet in the world. It is certainly a very demanding and dangerous plane to fly — recreational flyers beware!

The BD-5 was designed by Jim Bede of Bede Aircraft during 1971 and 1972 as an ultralight self-powered glider. The original powered design featured a small prop in the tail that could push the aircraft up to 212 mph. The plane was sold in kit form to flying enthusiasts. Although hundreds of kits were sold, about 40 have been completed and taken to the air.

The BD-5J is a jet-powered variant that first flew in 1973. It retains the famous "bullet" fuselage and retractable tricycle landing gear of the prop version. The wings were redesigned to hold a 50-gallon fuel tank for the turbojet, and strengthened to handle the greater weight of the jet version.

The BD-5J with its 220-lb thrust powerplant has an absolute maximum airspeed of 346 mph (controls lock in an uncontrollable dive at any higher speeds), stalls at 66 mph and climbs 3,200'/minute. The maximum ceiling is 30,000', but above 10,000' you'll need oxygen.

The BD-5 design is not a forgiving one. At least 24 accidents or incidents involving the aircraft are known, including seven fatal crashes. Of course, with kit-built versions, it is possible the fault lay in the construction, rather than the design. However takeoffs, landings, and low speed flying require particularly careful control of this temperamental and "high strung" thoroughbred.

Bede Aircraft is no longer in business making BD-5 kits. However, the fame and popularity of the design are so great that another firm is working on making the BD-5 available once more.

The BD-5J Pilot: A Special Breed

The BD-5J is an extraordinarily small, fast, responsive and agile plane. One of the world's premier aerobatic pilots, Corkey Forno, owns and uses it for TV and movie stunt flying, and in various airshows.

Your BD-5J is a plane for the ultimate grandstander. Standing on the ground in the "flight line" it attracts lots of attention. As a BD-5J pilot you'll be at the center of every hanger bull session! Just getting airborne and landing again requires plenty of care and skill — the BD-5 is a killer if not handled correctly. At altitude this jet-powered bullet can streak past traditional prop-powered biplanes and monoplanes. Performing aerobatics in the BD-5J tests the mettle of the best pilots. Its size and maneuverability allows a top pilot to perform difficult and precise maneuvers such as a 16 point roll, or a vertical roll and tailslide. In fact, the BD-5J may be the only jet in the world performing these aerobatics!

Perhaps the most memorable use of the BD-5J was by James Bond (007) to attack and destroy a secret installation at an airplane hanger — by flying *inside* the hanger with a BD-5J! This bit of daring-do was portrayed in the movie Octopussy,

with Corkey at the controls. In fact, the BD-5J is an excellent choice for a clandestine "quick strike": it is tiny, very maneuverable and very fast. Unfortunately, the 50 gallon fuel tank allows only one to two hours flying time. Fortunately, such a small plane can land on a third of a mile of flat roadway for quick refueling. Then again, the secret agent needs to be an exceptional pilot to handle the BD-5J as well as Corkey Fornof!

BD-5J AcroJet Specifications

Dimensions:
Length: 14' 9"
Wingspan: 17' 0"
Height: 6' 1"
Weight Empty: 430 lbs
Maximum Gross Weight: 950 lbs
Fuel Capacity: 50 gallons

Powerplant:
TRS-18 Ames Industrial Turbojet
Thrust: 220 lbs
Redline Exhaust Gas Temperature: 700° F
Weight: 75 lbs
Fuel Consumption: 38 gallons per hour at cruising speed

Performance:
Cruising Speed at 12,000': 233 mph
Full Performance Airspeed: 301 mph
Redline Airspeed: 346 mph
Maximum Endurance: 2 hours, 15 minutes
Stall Speed (flaps up): 66 mph
Stall Speed (full flaps): 55 mph

Takeoff & Landing Performance:
Nosewheel liftoff: 65 mph
Landing Pattern: 125 mph
Final Approach: 100 mph
Touchdown (flaps up): 80 mph
Touchdown (20° flaps): 75 mph
Touchdown (40° flaps): 70 mph

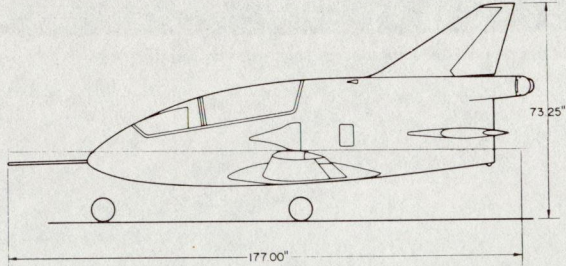
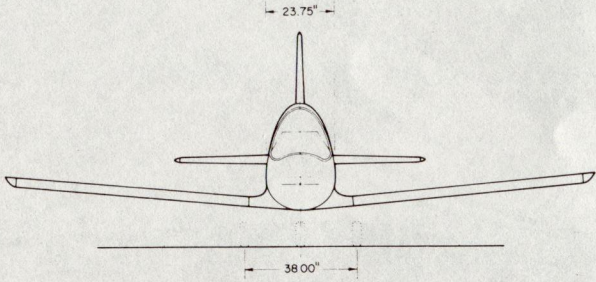
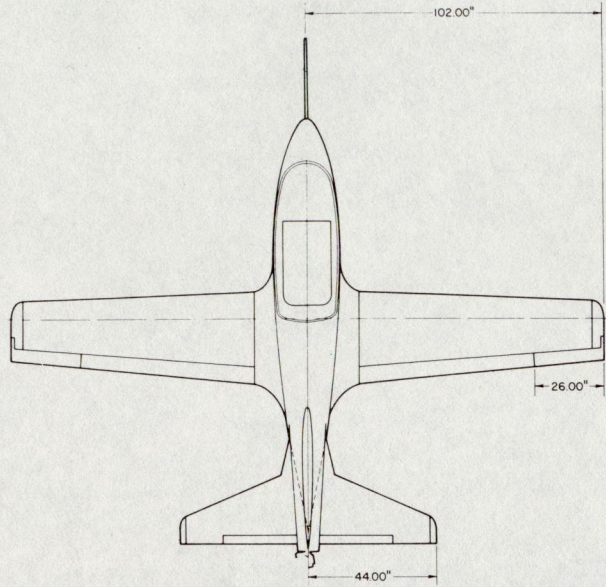

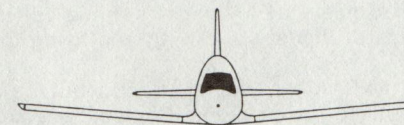

SPORT AVIATION

Yesterday

Daring individualism has been the hallmark of flying from the first powered flight at Kitty Hawk on December 17, 1903. Early aviators were often designers and mechanics as well as pilots. Structure and power plant were adjusted minutes before take-off. Flying was a profession for death-defying grandstanders and showmen, not unlike a circus. In 1914 Lincoln Beachey could be hired by fairs and cities to fly one loop for \$500, plus \$200 more for each additional loop he could perform. Beachey himself was killed a year later when his wings collapsed during a Split-S maneuver over San Francisco Bay. Pilots didn't have parachutes then.

World War I gave aircraft a practical purpose, but the tradition of aerobatic flying continued afterward with the 1920's barnstormers. This was fueled by the availability of war-trained pilots and war-surplus aircraft. Meanwhile, aircraft design was advancing by leaps and bounds. The boasts of designers and manufacturers inspired two types of racing: closed-circuit pylon races, and long cross-country or transcontinental races and challenges. The most famous were the Schneider Trophy for the fastest seaplane, and the Thompson Trophy for landplanes. Famous racing flyers such as Roscoe Turner were household words and front-page news. Hundreds of thousands of spectators turned out to see air races, their interest peaked by all too common crashes. In fact, the mortality rate was so high that in 1939 even the indefatigable Turner retired.

During World War II aerobatic flying again became a deadly game, now performed with high-speed monoplanes powered by giant 2000+ horsepower engines at speeds between 350 and 450 mph. In fact the late-war fighters now represent the apex of high-performance prop plane design. Those designs are rebuilt or copied today by "warbird" enthusiasts. After WWII surplus planes were again cheap — so cheap that many ordinary people could afford them. The number of trained flyers was also huge, and many wanted to keep flying. The result is an entire new generation of build-them-yourself airplane kits, low cost powered and unpowered designs, and a variety of low-cost factory-built products.

Today

Modern "barnstormers" still exist, flying in airshows around the USA, and not infrequently performing stunts for TV and movie production. They don't crash as much, and are actually rather modest fellows, so you don't hear about them often. Frank Tallman and Corkey Fornof are well-regarded men of this breed. Mr. Fornof flies a BD-5J frequently, although he's flown over 140 other planes during his career.

Meanwhile at small airfields around the world private citizens purchase planes or build their own, and then fly them for pleasure. It is possible to buy a small aircraft or powered glider for the price of a good car, or to buy one in kit form for the price of a good motorcycle. In the USA sport flyers gather and communicate through the EAA (Experimental Aircraft Association). The EAA has divisions for antique and classic aircraft, "warbirds" from WWII, modern ultralight craft, and the IAC (Internation-

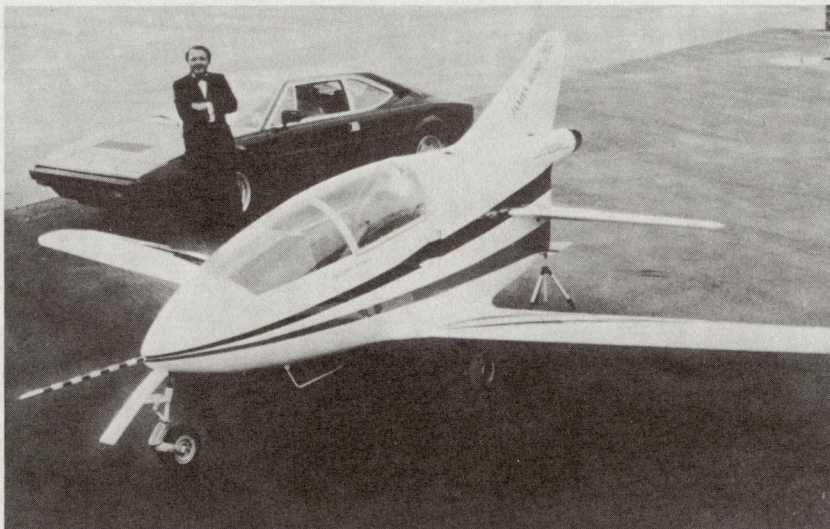

A typical secret agent beside his BD-5J camouflaged as an air-show craft.

tional Aerobatic Club). In August the EAA holds its annual convention in Oshkosh, Wisconsin, with hundreds of thousands driving and flying in from around the nation.

The IAC division of the EAA has chapters throughout the USA, and many of these sponsor local aerobatic competitions. Competitions are typically in four divisions, so that flyers of equivalent abilities can compete. In 1967 Count Aresti of Spain created a system for rating the difficulty of various aerobatic maneuvers. In competition flyers perform routines composed of these maneuvers, and are judged on their skill and precision.

Air races are still held in the USA, the most famous being the races in Reno, Nevada. The race has categories for various types of aircraft. The "unlimited" class of prop planes is the best known and most visible, especially since many of the planes are modified WWII fighters.

Every two years an international competition of aerobatic flyers occurs among five-man and five-woman teams from each nation. The 1984 World Championship held in Bekescsaba, Hungary was won by Petr Jimus of Czechoslovakia (men's division) and Khalide Makagonova of the USSA (woman's division). However, the US men's team had the highest total score, and the US women's team had the second highest total. The next world championship will be in Cranfield, England, during August of 1986. The US National Competition to select the American team is in Sherman/Denison, Texas during September of 1985.

Competitive aerobatic flying is a small and often ignored sport, but probably the most demanding to them all — especially given its high safety record (aerobatic flyers sense that a poor safety record would rapidly doom the sport!). Stunt pilot Frank Tallman's remarks on aerobatic flying are worth pondering: "... for me to get in and do an international course of aerobatics in the Chipmunk or a Pitts — forget it." The Pitts Specials and Chipmunks are prop planes. Nobody thought to ask Frank what he thought about flying a 15' long aerobatic *jet* through ribbon gates!

More about Sport Aviation

To learn more about sport aviation and aerobatics, we suggest that you become a member of the EAA and IAC. Write to the Experimental Aircraft Association, Wittman Airfield, Oshkosh, WI, 54903-2591. Membership entitles you to their monthly magazines "Sport Aviation" (EAA) and "Sport Aerobatics" (IAC) respectively. Detailed schedules of conventions and competitions are published regularly, along with many interesting articles and advertisements.

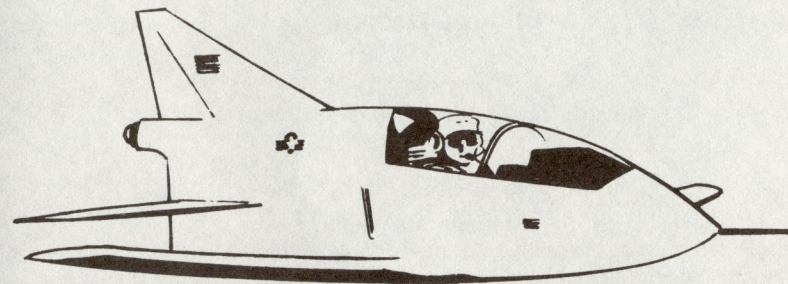

DEDICATION

This simulation is dedicated to sport aviators and
aerobatic pilots everywhere.

CREDITS

DESIGN & PROGRAMMING:

William F. Denman, Jr.
with Edward N. Hill, Jr.

ART & COMPUTER GRAPHICS:

Michael Haire

BD-5J TECHNICAL ASSISTANCE & PHOTOGRAPHS:

J.W. "Corkey" Forno and Bearcat Enterprises Inc.
(Houma, Louisiana)

STUNTS:

Wild Bill Stealey

DOCUMENTATION:

Arnold Hendrick

PLAYTESTING:

Guy Watkins, Jay Trotta, John Harris, Silas Warner

Software Authors!

MicroProse is always searching for new people and products, to bring you the most challenging and fun products. If you're creating quality simulation software, and/or are an expert in 6502, 8086 or 68000 programming, call or write us! We'd like to get you on our team and make you a MicroProse partner!

COPYRIGHT NOTICE

COPYRIGHT ©1985 BY MICROPROSE SOFTWARE INC., ALL RIGHTS RESERVED. This manual and the computer programs and audiovisuals on the accompanying floppy disks, which are described by this manual, are copyrighted and contain proprietary information belonging to MICROPROSE SOFTWARE, INC. No one may give or sell copies of this manual or the accompanying disks or of listings of the programs on the disks to any person or institution, except as provided for by the written agreement with MICROPROSE SOFTWARE, INC. No one may copy, photocopy, reproduce, translate this manual or reduce it to machine readable form, in whole or in part, without the prior written consent of MICROPROSE SOFTWARE, INC. Any person/persons reproducing any portion of this program, in any media, for any reason, shall be guilty of Copyright Violation, and shall be subject to civil liability at the discretion of the copyright holder.

WARRANTY AND LIABILITY

Neither MICROPROSE SOFTWARE, INC., nor any dealer or distributor makes any warranty, express or implied, with respect to this manual, the disk or any related item, their quality, performance, merchantability, or fitness for any purpose. It is the responsibility solely of the purchaser to determine the suitability of the products for any purpose. To the original purchaser only, MICROPROSE SOFTWARE, INC. warrants the media to be free from defects in material for 90 days. If during that period a defect should occur, the software may be returned to MICROPROSE SOFTWARE, who will replace the media at no charge. If at any time after the initial 90 day period your media becomes defective, the media may be returned to MICROPROSE SOFTWARE for replacement at a \$10 service charge. To ensure identification the original purchaser must complete and mail the Registration/Warranty card enclosed in this product. In no case will MICROPROSE SOFTWARE, INC. be held liable for direct, indirect or incidental damages resulting from any defect or omission in the manual, or other related items and processes, including, but not limited to, any interruption of service, loss of business, anticipated profit, or other consequential damages.

MICRO PROSE
SIMULATION • SOFTWARE

2, Market Place, Tetbury, Gloucestershire GL8 8DA

Tel:(0666)54326

Fax:(0666)54331 Tlx:43422MPS UK G